

Celestyn Series Ceiling Lights

BCL-108-x



Overview

The Celestyn Series features a wide array of ceiling lights that enhance greatly the visibility and ambience of its surroundings. The Celestyn Series is an ideal replacement for traditional compact fluorescent lighting (aka PLC lighting) or traditional halogen lamps as they are considerably more energy-efficient as well as producing virtually no heat.

Key Features

- Ceiling recessed LED downlight made with an aluminium body for robust usage
- Heat sink design incorporated into light housing for maximum heat discharge effectiveness
- Long lifespan of up to 50,000 hours

Ordering Code

Ceiling Lights Series	BCL-108	Led Power: 3=3W
	03	Beam Angle: 25/40/60 Degrees
	25	Lighting Direction: A=Adjustable
	A	Colour Of Light: WW=Warm White, CW=Cool White
	CW 00	Option: 00=No Diffuser

LED POWER

3W

Mechanical Dimensions

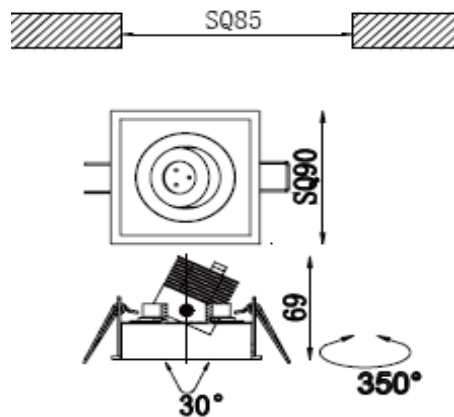

Celestyn Series

Data Sheet

Specifications

Lumen Output

- 3x1W: 240 lm(WW), 240 lm(CW)

Beam Angle

- 25/40/60 degrees

Lighting Direction

- Adjustable +/- 30 degrees

Colour Of Light

- Cool White (Typical 6000K)
- Warm White (Typical 3000K)

CRI

- >80

Input Voltage

- 100-240VAC @50HZ

Relative Humidity

- 98% Non-condensing

Operating Temperature

- -20° to +50° C

IP Rating

- IP 20 (Indoor Use and side walk areas)

Power Consumption

- 3W

Life Span

- Up to 50,000 hours

Safety Certification Standards

- CE, FCC, RoHs

Colour Of Body

- Matt White

Weight

- 0.30 kg

Materials

- Heavy duty aluminum alloy, cold rolled steel

Specifications in this document are subject to change without notice.

BONJOUR ODYSSEY PTE LTD

135 Joo Seng Road, PM Industrial Building, #03-01, Singapore 368363

Tel: 65-64874568, Fax: 65-64876598

Email: Sales@Bonjour-Odyssey.com

URL: www.bonjour-odyssey.com

Bonjour
Odyssey

We Help You Save Energy Costs